

2 osoby



wiek



PN-EN:1176:2009



dostępne części zapasowe



wymaga nawierzchni bezpiecznej



178 x 24 x 84 cm



478 x 324 cm



50 cm

## SPECYFIKACJA:

Materiały:

**Kształt bujaka i siedzisko:** płyta HDPE

**Sprężyna:** zwojowa, gr. 20mm, malowana proszkowo

**Uchwyty:** tworzywo sztuczne

Montaż:

(osadzenie w gruncie)

**fundamenty:** beton klasy min. B20

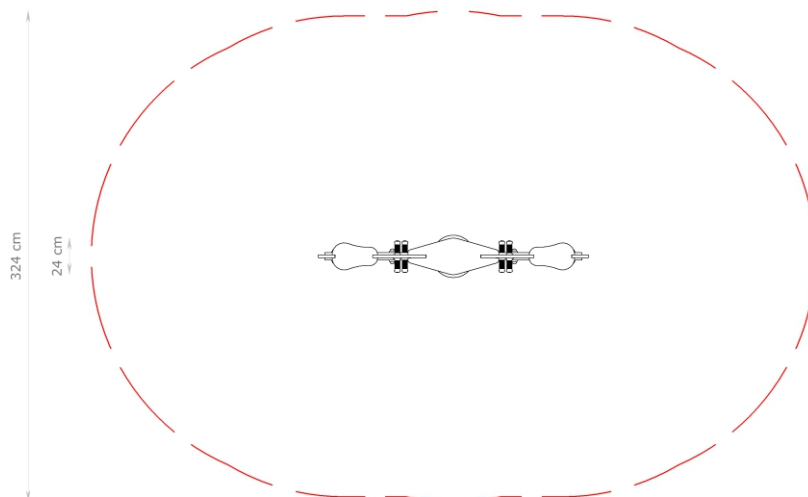
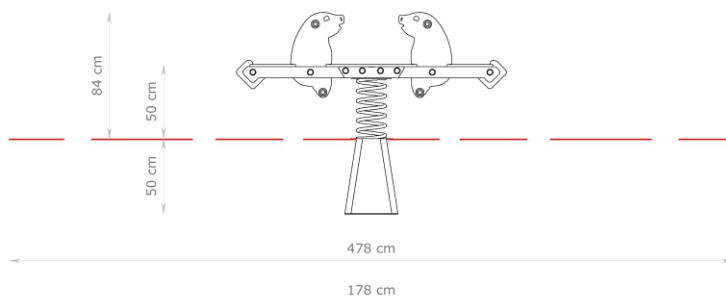

Dostępna kolorystyka:

