

2 osoby



wiek



PN-EN:1176:2009



dostępne części zapasowe



wymaga nawierzchni bezpiecznej



178 x 24 x 83 cm



478 x 324 cm



50 cm

SPECYFIKACJA:

Materiały:

Kształt bujaka i siedzisko: płyta HDPE

Sprężyna: zwojowa, gr. 20mm, malowana proszkowo

Uchwyty: tworzywo sztuczne

Montaż:

(osadzenie w gruncie)

fundamenty: beton klasy min. B20

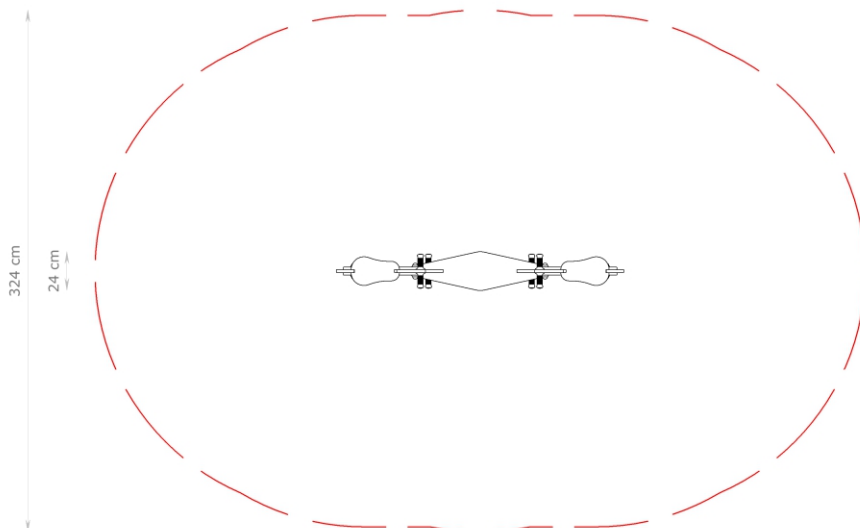
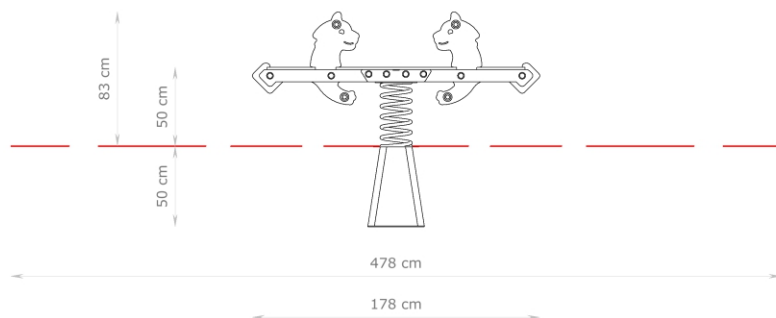

Dostępna kolorystyka:

